Muscle BioAmp Candy

Upside Down Labs

Apr 02, 2026

CONTENTS

1	Muscle BioAmp Candy	1
1.1	Overview	1
1.2	Features & Specifications	2
1.3	Hardware	2
1.4	Contents of the kit	4
1.5	Software requirements	4
1.6	Using the kit	6
1.6.1	Step 1: Connect Arduino UNO R3	6
1.6.2	Step 2: Connecting electrode cable	7
1.6.3	Step 3: Skin Preparation	7
1.6.4	Step 4: Measuring EMG (ElectroMyoGraphy)	7
2	Skin Preparation Guide	10
2.1	Why skin preparation is important?	10
2.2	Kit Contents	10
2.3	Steps to follow	11
2.3.1	Step 1: Identify the targeted area	11
2.3.2	Step 2: Apply NuPrep gel	11
2.3.3	Step 3: Clean the skin surface	11
2.3.4	Step 4: Wipe off the gel	15
2.3.5	Step 5: Measuring the signals	15
3	Using BioAmp Bands	18
3.1	Overview	18
3.2	Why use BioAmp Bands?	18
3.3	Types of BioAmp Bands	18
3.3.1	1. Muscle BioAmp Band	19
3.3.2	2. Heart BioAmp Band	19
3.3.3	3. Brain BioAmp Band	20
3.4	Using Muscle BioAmp Band	21
3.4.1	Assembly	21
3.4.2	Skin Preparation	23
3.4.3	Measure EMG	23
3.5	Using Heart BioAmp Band	25
3.5.1	Skin Preparation	25
3.5.2	Assembly	25
3.5.3	Measure ECG	27
3.6	Using Brain BioAmp Band	28
3.6.1	Assembly	28
3.6.2	Skin Preparation	28
3.6.3	Measure 1-channel EEG	28

MUSCLE BIOAMP CANDY

1.1 Overview

A candy-size single-channel ElectroMyography (EMG) sensor for recording of muscle signals at an affordable cost. It is an SMD version of muscle-bioamp-biscute that can be used to make amazing Human-Computer Interface (HCI) projects.

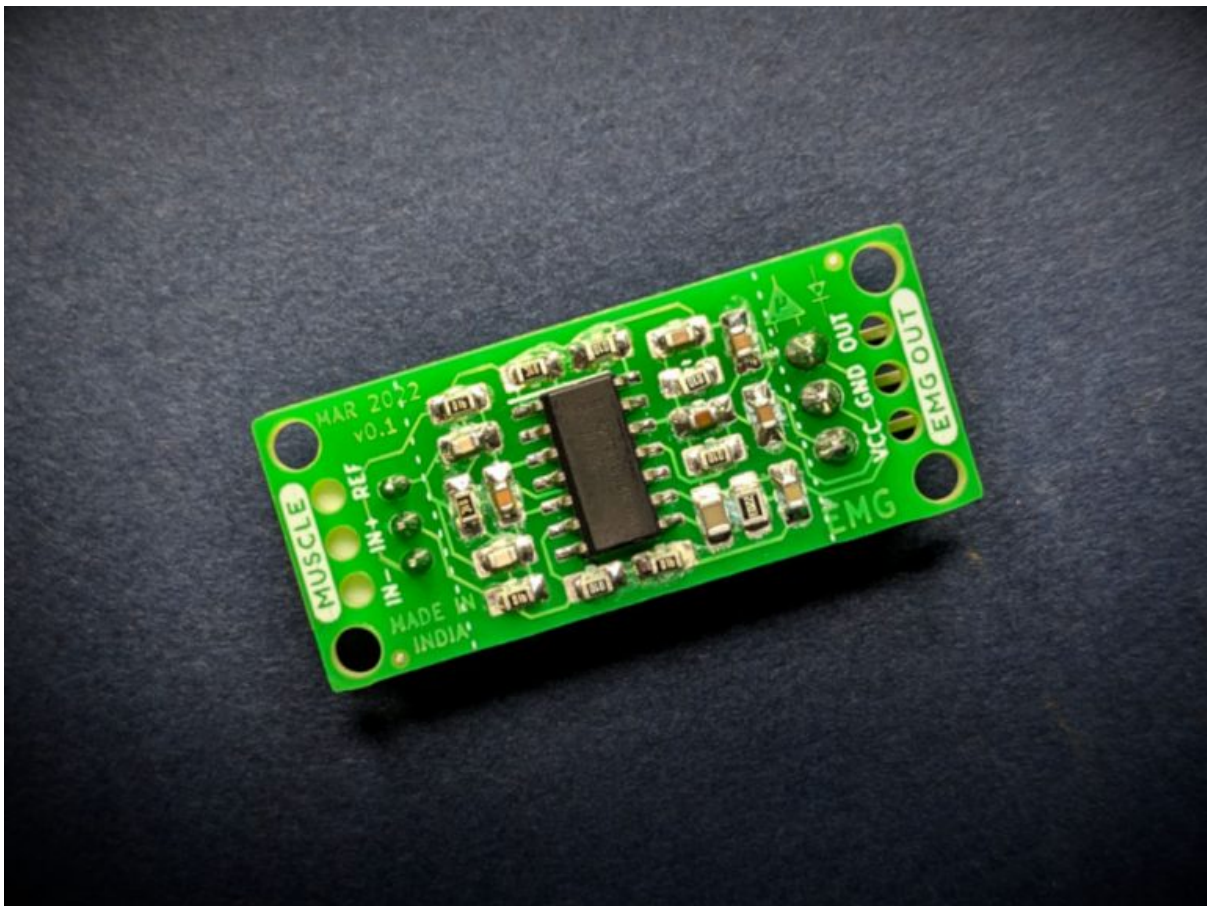

1.2 Features & Specifications

Minimum Input Voltage	3.3-30 V
Input Impedance	10^{11} ohm
Fixed Gain	x2420
Bandpass filter	72 – 720 Hz
Compatible Hardware	Any development board with an ADC (Arduino UNO & Nano, Adafruit QtPy, STM32 Blue Pill, BeagleBone Black, Raspberry Pi Pico, to name just a few)
BioPotentials	EMG (Electromyography)
No. of channels	1
Electrodes	3 (Positive, Negative, and Reference)
Dimensions	3.5 x 1.5 cm
Open Source	Hardware + Software

1.3 Hardware

Images below shows a quick overview of the hardware design.

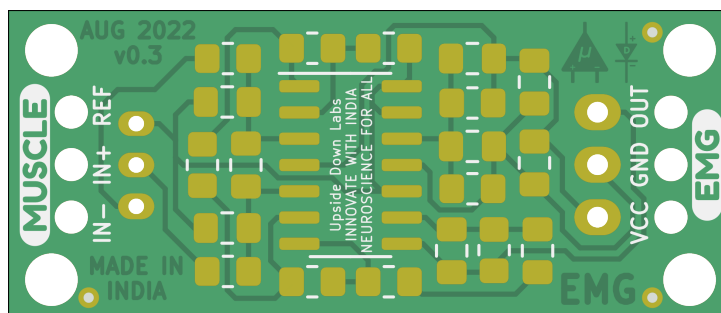

Fig. 1: PCB Front

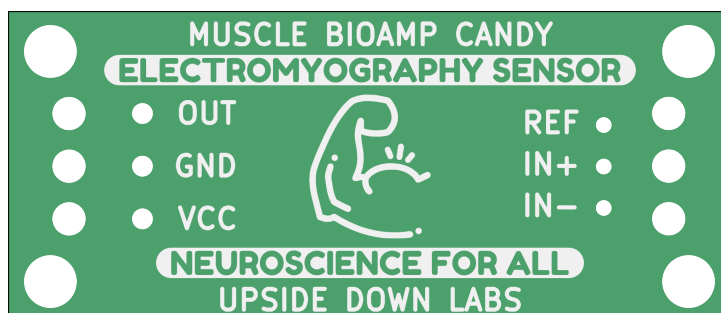

Fig. 2: PCB Back

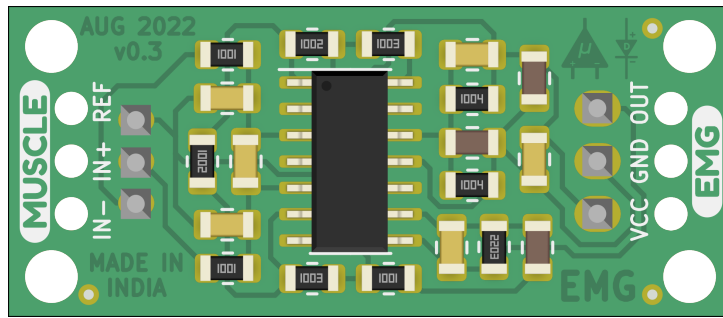

Fig. 3: Assembled PCB - Front

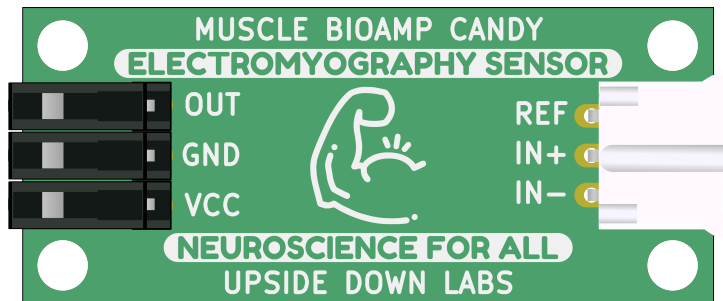

Fig. 4: Assembled PCB - Back

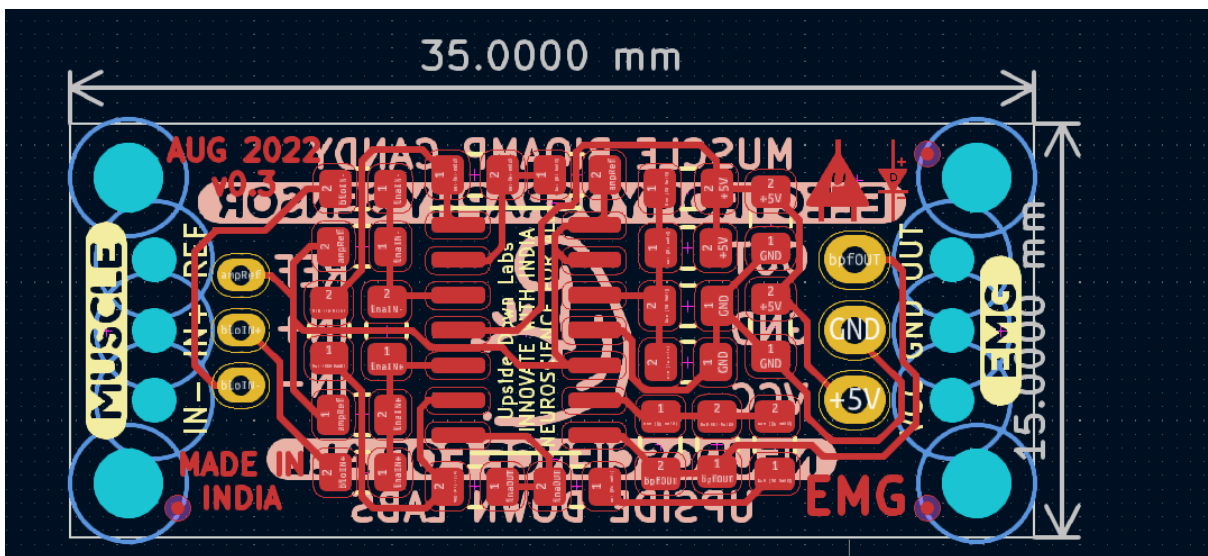

Fig. 5: PCB Layout

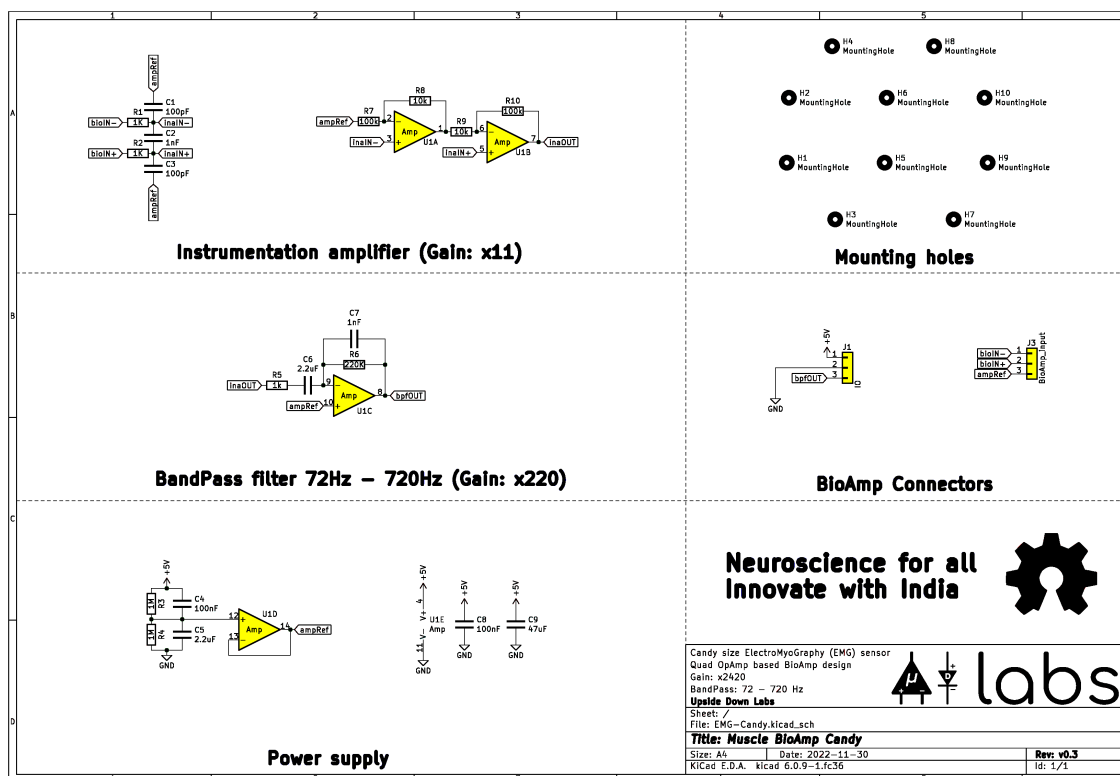

Fig. 6: Schematic Diagram

1.4 Contents of the kit

Contents of the kit	Qty
Muscle BioAmp Candy	1
BioAmp Cable v3	1
Jumper cables (set of 3)	1
Muscle BioAmp Band	1
Boxy gel electrodes	3

1.5 Software requirements

Before you start using the kit, please download [Arduino IDE v1.8.19 \(legacy IDE\)](#). Using this you'll be able to upload the arduino sketches on your development board and visualise the data on your laptop.

Visit Upside Down Labs [Chords Web](#) to visualize your bio-potential signals directly in the browser.

Getting started with Chords Web

<https://youtu.be/IVIPnk9z75g>



**Each pack comes with a bunch of surprise goodies!!*

Fig. 7: Kit contents

Legacy IDE (1.8.X)



Arduino IDE 1.8.19

The open-source Arduino Software (IDE) makes it easy to write code and upload it to the board. This software can be used with any Arduino board.

Refer to the [Arduino IDE 1.x documentation](#) for installation instructions.

SOURCE CODE

Active development of the Arduino software is [hosted by GitHub](#). See the instructions for [building the code](#). Latest release source code archives are available [here](#). The archives are PGP-signed so they can be verified using [this](#) gpg key.

DOWNLOAD OPTIONS

Windows Win 7 and newer
Windows ZIP file

Windows app Win 8.1 or 10 

Linux 32 bits
Linux 64 bits
Linux ARM 32 bits
Linux ARM 64 bits

Mac OS X 10.10 or newer

[Release Notes](#)

[Checksums \(sha512\)](#)

Fig. 8: Arduino IDE v1.8.19 (legacy IDE)

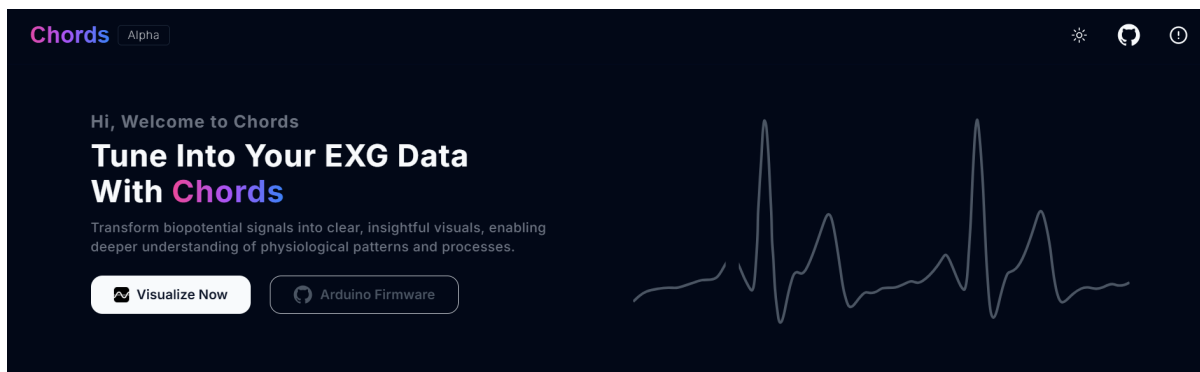
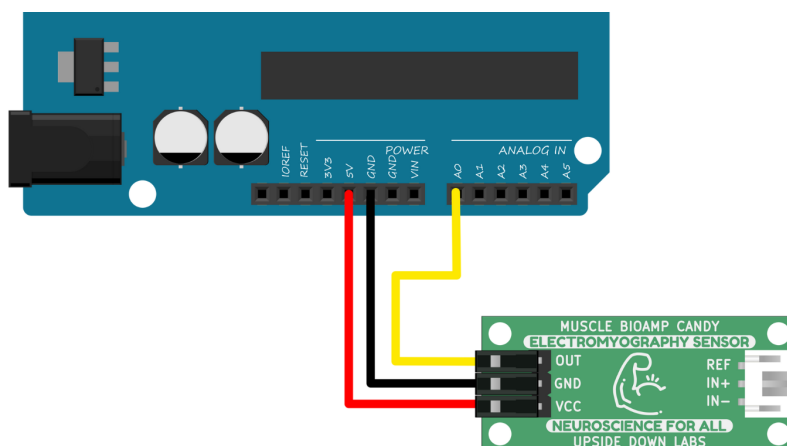

Fig. 9: Chords Web Landing Page

1.6 Using the kit

1.6.1 Step 1: Connect Arduino UNO R3

Connect VCC to either 5V or 3.3V, GND to GND, and OUT to Analog pin A0 of your Arduino UNO via jumper cables provided by us. If you are connecting OUT to any other analog pin, then you will have to change the *INPUT PIN* in the example arduino sketch accordingly.



Note

For demonstration purposes we are showing connections of the sensor with Arduino UNO R3 but you can use any other development board or a standalone ADC of your choice.

Warning

Take precautions while connecting to power, if power pins (GND & VCC) are to be swapped, your sensor will be fried and it'll become unusable (DIE).

1.6.2 Step 2: Connecting electrode cable

Connect the BioAmp cable to Muscle BioAmp Candy by inserting the cable end in the JST PH connector as shown.

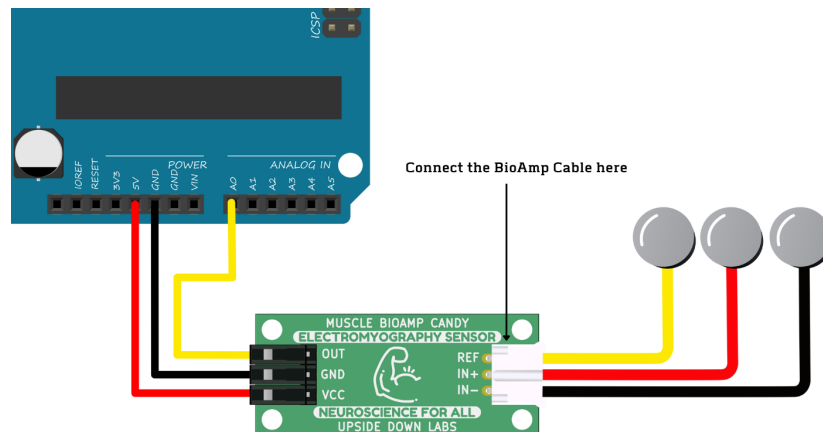

1.6.3 Step 3: Skin Preparation

Apply Nuprep Skin Preparation Gel on the skin surface where electrodes would be placed to remove dead skin cells and clean the skin from dirt. After rubbing the skin surface thoroughly, clean it with an alcohol wipe or a wet wipe.

For more information, please check out detailed step by step *Skin Preparation Guide*.

1.6.4 Step 4: Measuring EMG (ElectroMyoGraphy)

Electrodes placement

We have 2 options to measure the EMG signals, either using the gel electrodes or using dry electrode based Muscle BioAmp Band. You can try both of them one by one.

- **Using gel electrodes:**

1. Connect the BioAmp cable to gel electrodes,
2. Peel the plastic backing from electrodes
3. Place the IN+ and IN- cables on the arm near the ulnar nerve & REF (reference) at the back of your hand as shown in the connection diagram.

- **Using Muscle BioAmp Band:**

1. Connect the BioAmp cable to Muscle BioAmp Band in a way such that IN+ and IN- are placed on the arm near the ulnar nerve & REF (reference) on the far side of the band.
2. Now put a small drop of electrode gel between the skin and metallic part of BioAmp cable to get the best results.

Tip

Visit the complete documentation on how to *assemble and use the BioAmp Bands* or follow the youtube video given below.

Tutorial on how to use the band:

<https://youtu.be/xYZdw0aesa0>

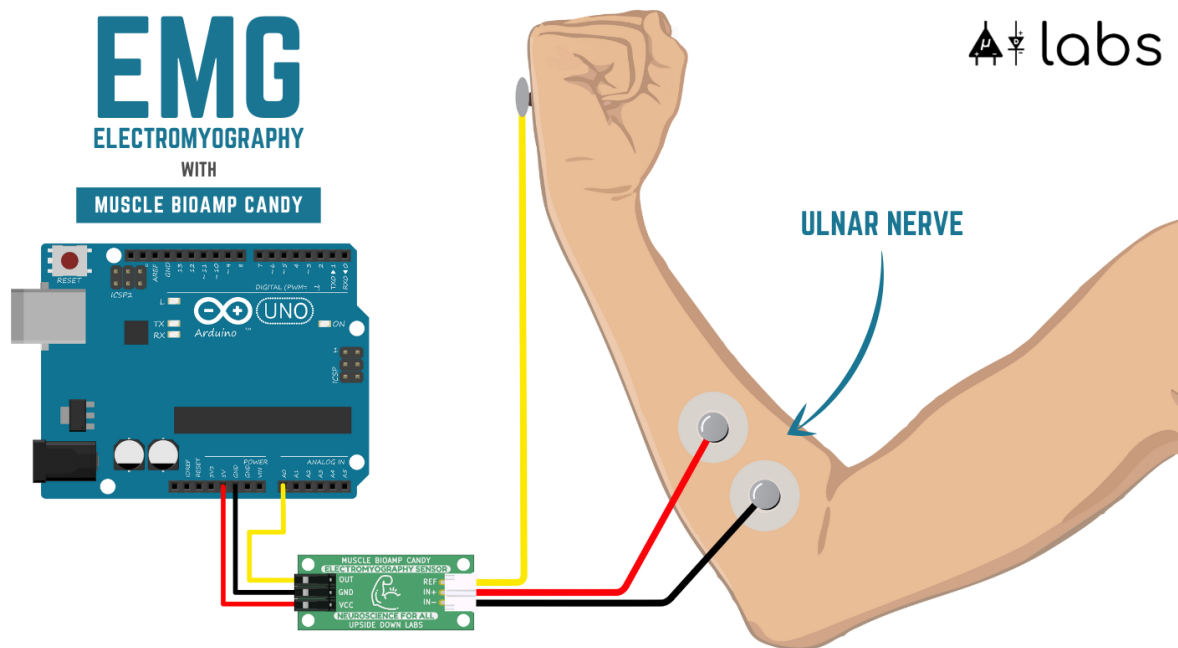

Note

In this demonstration we are recording EMG signals from the ulnar nerve, but you can record EMG from other areas as well (biceps, triceps, legs, jaw etc) as per your project requirements. Just make sure to place the IN+, IN- electrodes on the targeted muscle and REF on a bony part.

Uploading the code

Connect your Arduino UNO R3 to your laptop using the USB cable (Type A to Type B). Copy paste any one of the arduino sketches given below in Arduino IDE v1.8.19 that you downloaded earlier:

EMG Filter

EMG Envelope

Go to **tools** from the menu bar, select **board** option then select **Arduino UNO**. In the same menu, select the **COM** port on which your Arduino Uno is connected. To find out the right **COM** port, disconnect your board and reopen the menu. The entry that disappears should be the right **COM** port. Now upload the code, & open the serial plotter from the **tools** menu to visualize the EMG signals.

After opening the serial plotter make sure to select the baud rate to 115200.

Warning

Make sure your laptop is not connected to a charger and sit 5m away from any AC appliances for best signal acquisition.

Visualizing the EMG signals

For visualizing the EMG signals, use [Chords Web](#) for quick and hassle-free real-time bio-potential signals visualization right from your browser, without installing any software.

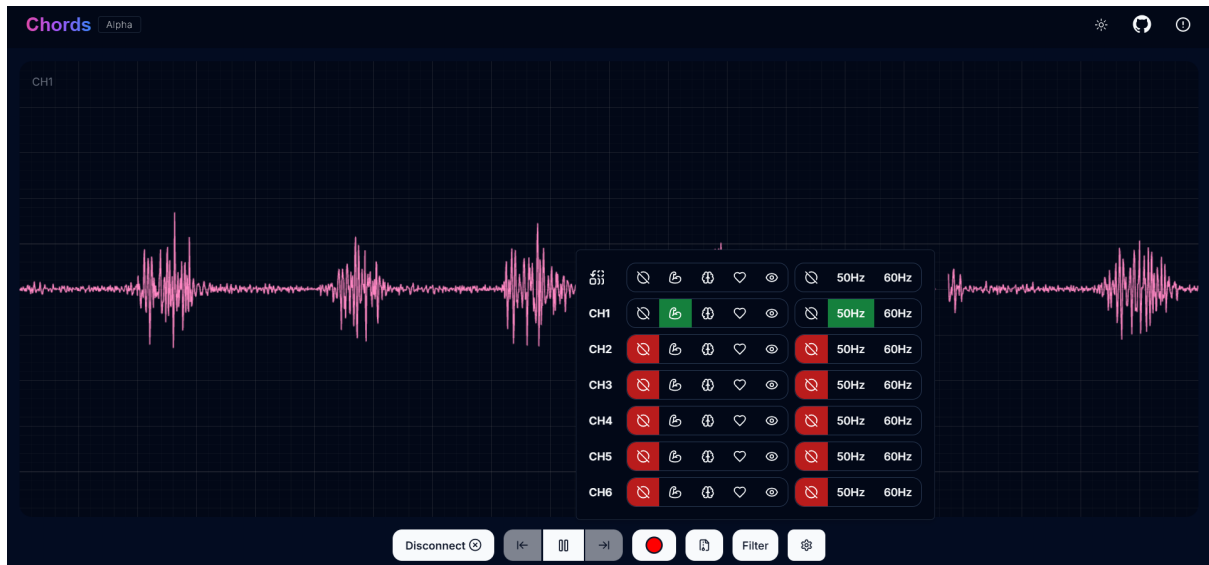

Fig. 10: Visualizing EMG signals on Chords Web

Now flex your arm to visualize the muscle signals in real time on your laptop.

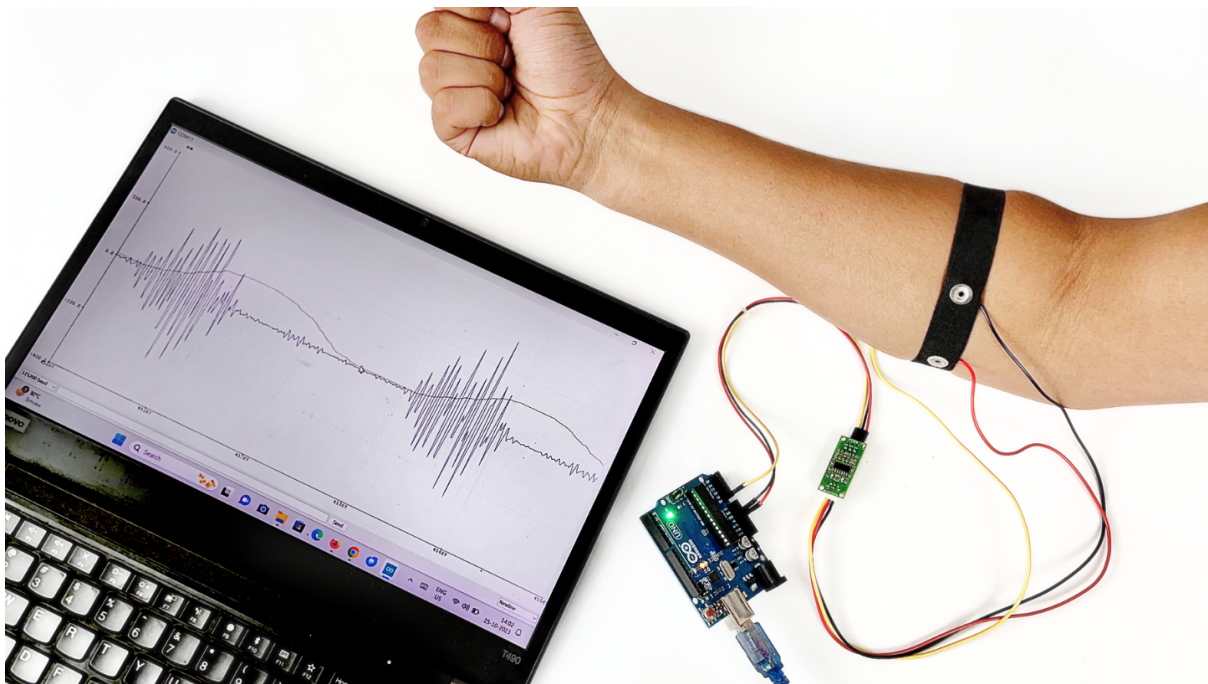

Fig. 11: Visualizing EMG signals on Arduino IDE v1.8.x

Video tutorial:

<https://youtu.be/IPX2TGBcHOA>

SKIN PREPARATION GUIDE

2.1 Why skin preparation is important?

Proper skin preparation is crucial before recording any biopotential signal be it Electrocardiography (ECG), Electromyography (EMG), Electroencephalography (EEG), or Electrooculography (EOG).

- **Clean skin surface:** Removes dead skin cells, oils, & other substances that increases skin impedance.
- **Improve impedance:** Improves the conduction of electrical signals from the body to the recording equipment and minimizes impedance.
- **Electrode-skin contact:** Ensures optimal contact between the electrodes and the skin surface.
- **Signal quality:** Enhances the overall quality of recorded signals, providing clear & reliable data for analysis & improves the ability to capture subtle variations in biopotential signals.
- **Consistency in recordings:** Reduces variability in signal quality, making it easier to make any Human-Computer Interface (HCI), Brain-Computer Interface (BCI) project or a real-world application.
- **Long term adhesion:** Facilitates long-term adhesion & stable placement of electrodes to the skin during extended signal monitoring.

2.2 Kit Contents

Nuprep gel	Mildly abrasive, highly conductive gel that should be applied before placing the electrodes on the skin to improve signal quality & enhances the performance of monitoring electrodes.
Electrode Gel	Highly conductive gel that acts as a coupling agent between dry electrodes and the skin to aid the transmission of biopotential signals like ECG, EMG, EOG, or EEG.
Ten20 paste	Contains the right balance of adhesiveness and conductivity, enabling the dry electrodes to remain in place while allowing the transmittance of biopotential signals.
Alcohol Swabs/Wet wipes	Soft & non-woven pads that helps in cleaning the skin surface and does not leave any residue.
Cotton Swabs	Useful while applying nuprep gel or ten20 paste.

Contents of the kit



NuPrep Gel



Cotton Swabs



Electrode Gel



Alcohol Swabs



Ten20 Paste

2.3 Steps to follow

You can follow the steps given below to do the skin preparation properly:

2.3.1 Step 1: Identify the targeted area

Identify the target area where the gel electrodes or BioAmp Bands will be placed for recording the biopotential signals.

2.3.2 Step 2: Apply NuPrep gel

Take a small amount of NuPrep gel using a cotton swab and apply it on your targeted area.

2.3.3 Step 3: Clean the skin surface

Use gentle, circular motions to rub the gel on the skin surface. This removes all the dead skin cells & improves conductivity.

Warning

Do not rub the gel for too long as it has abrasive properties and may cause skin redness and irritation.

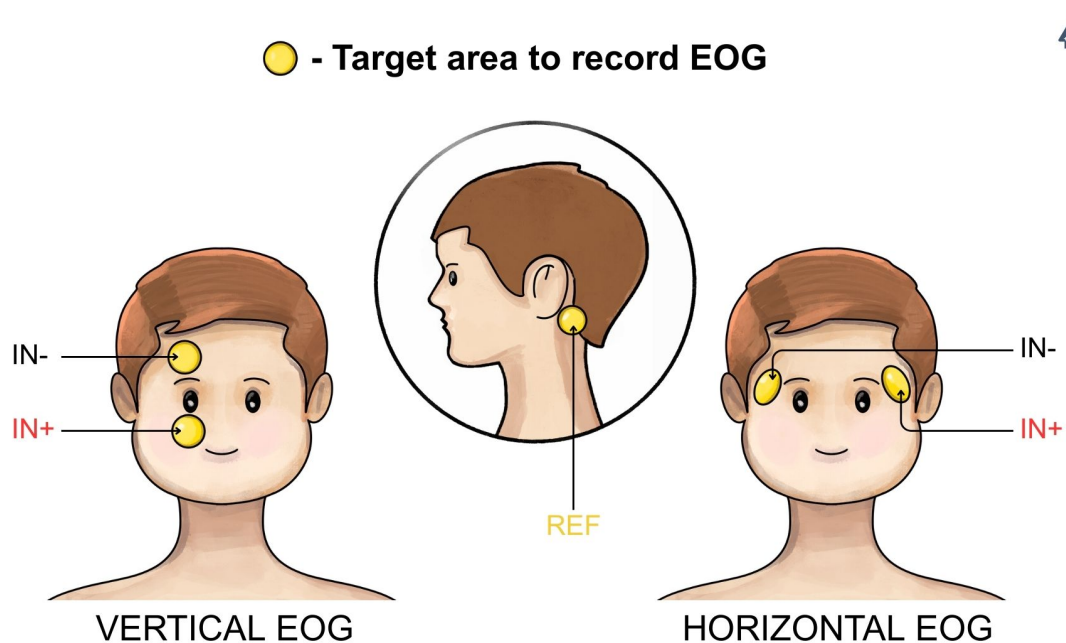

Fig. 1: Target area to record EOG

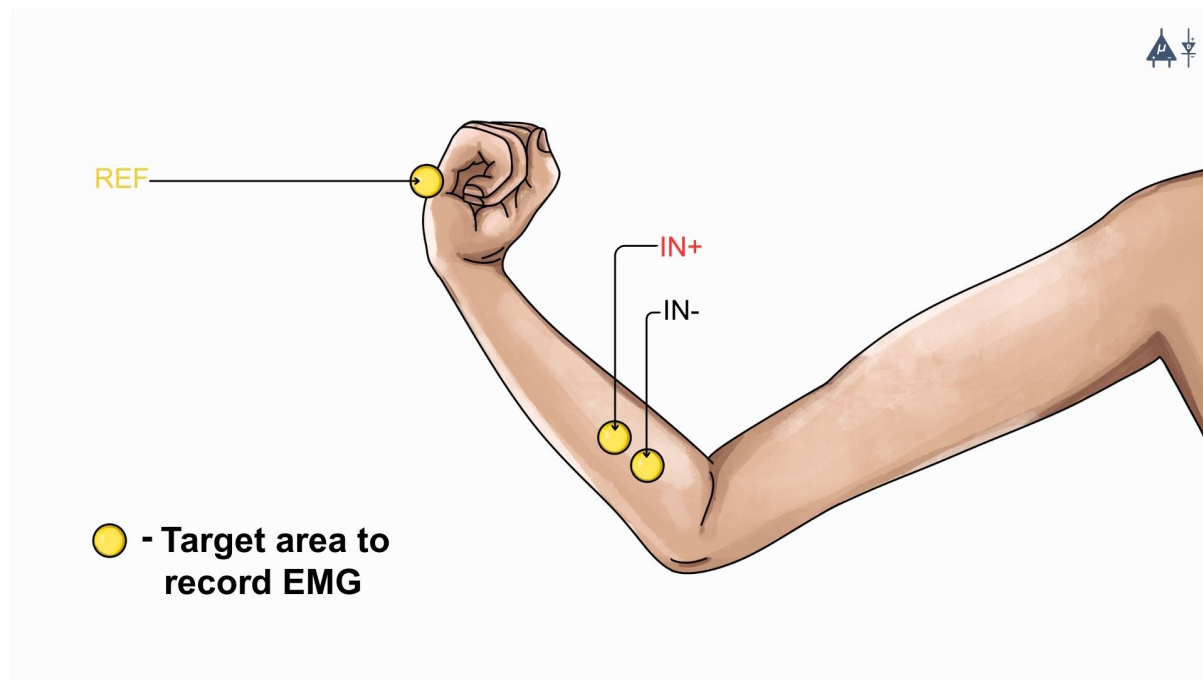

Fig. 2: Target area to record EMG

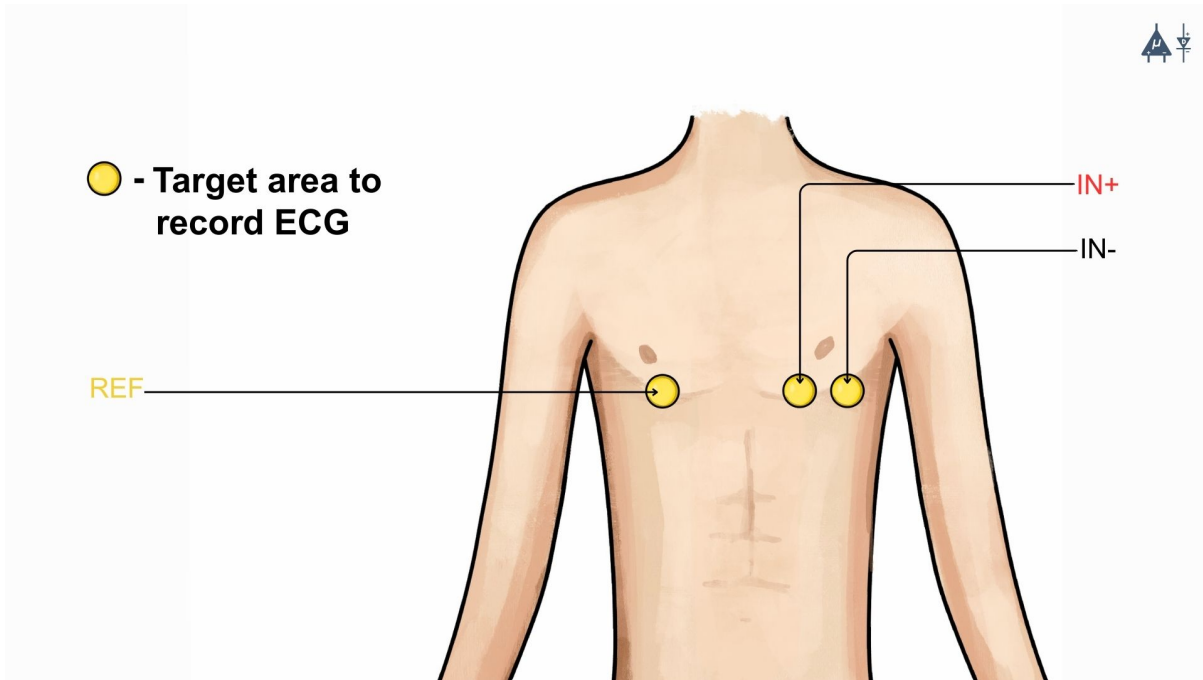

Fig. 3: Target area to record ECG

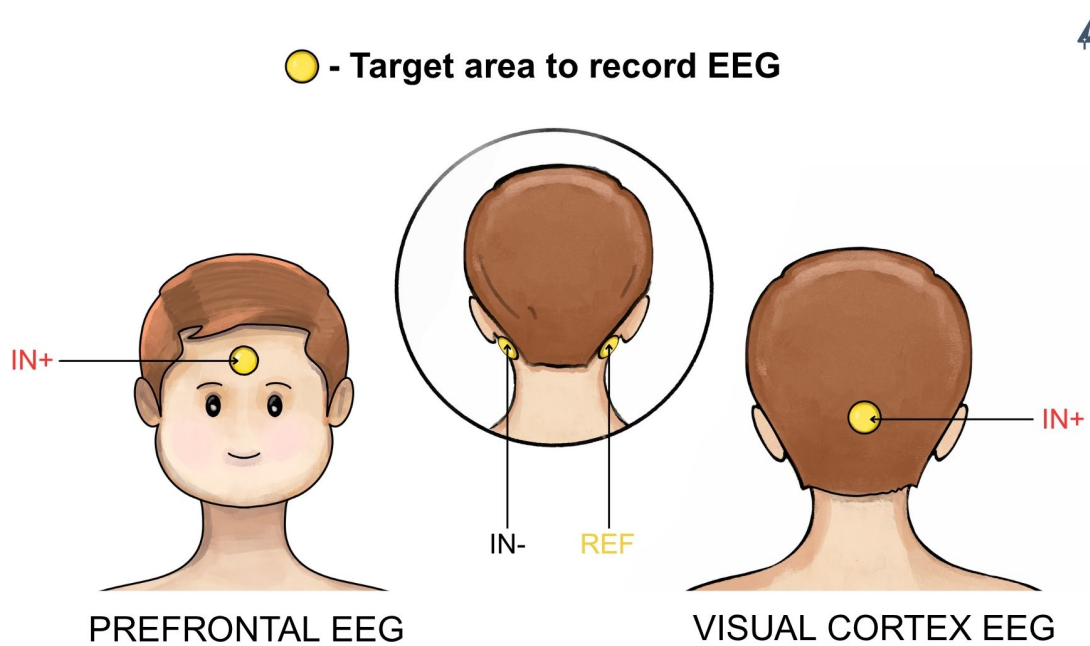

Fig. 4: Target area to record EEG

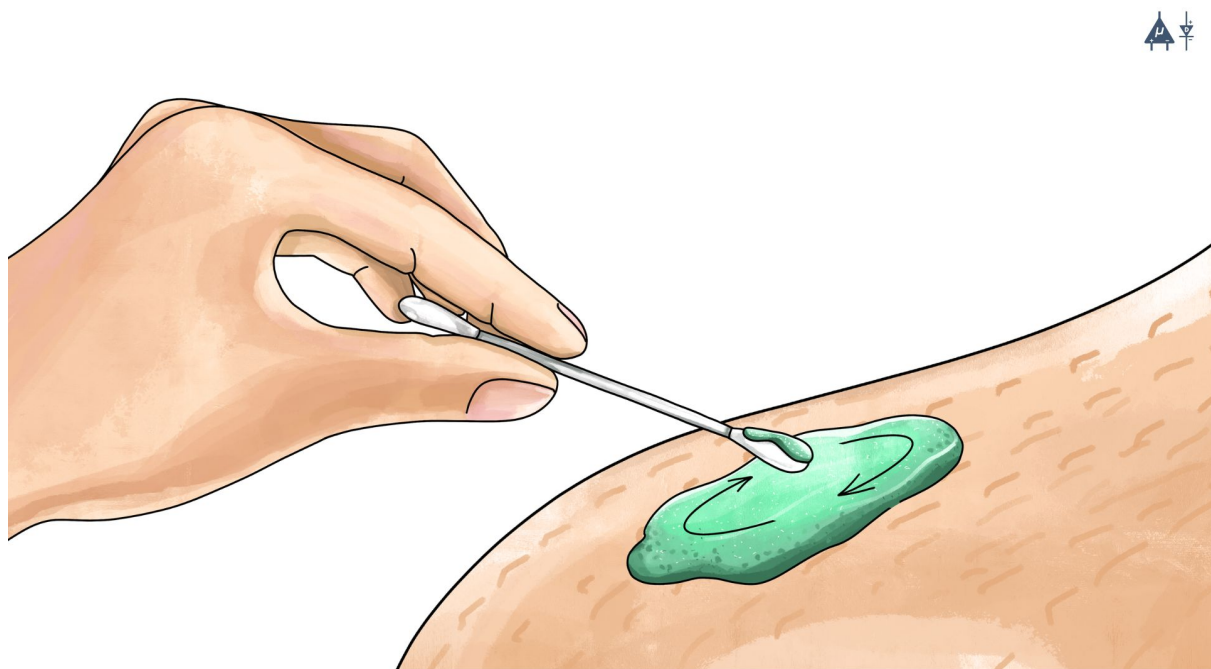
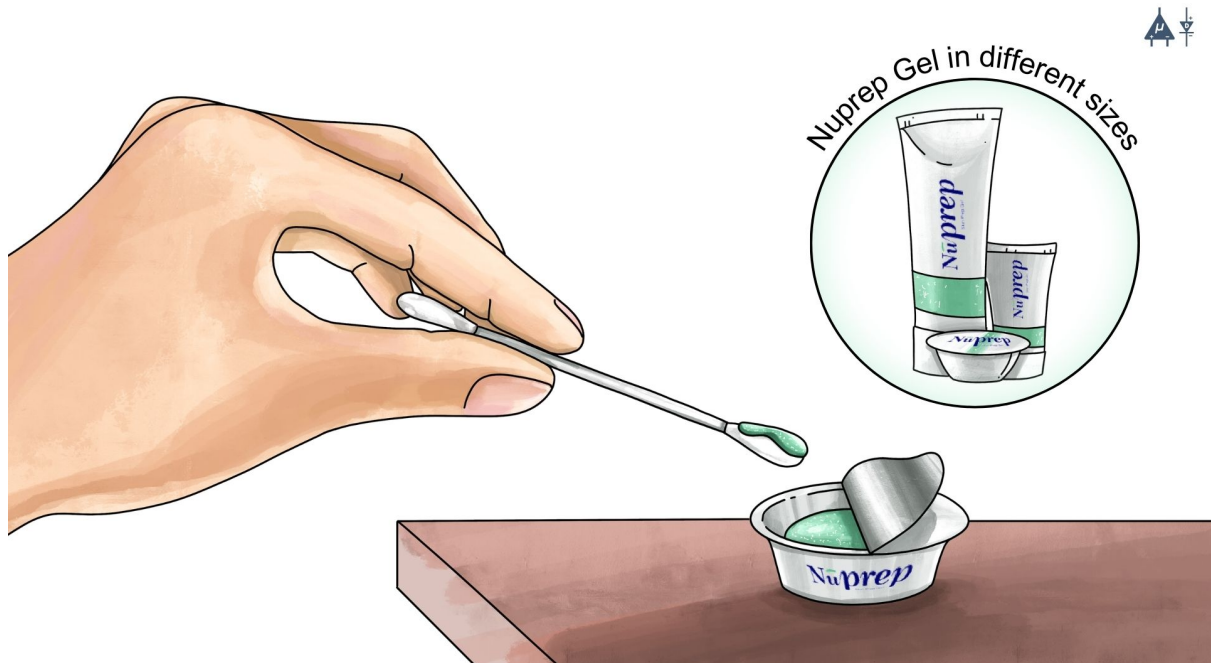

Fig. 5: Rub the gel gently using the cotton swab

2.3.4 Step 4: Wipe off the gel

Wipe away excess gel with alcohol swabs or wet wipes.



Fig. 6: Wipe away excess gel

Warning

- Using alcohol swabs can dry out the skin, so don't use them if your skin is already dry.
- Close your eyes while using the alcohol swabs for EOG recording else it may cause eye redness & irritation.

2.3.5 Step 5: Measuring the signals

Now you can either use gel electrodes or BioAmp bands for the signal recording.

Using gel electrodes

Connect the BioAmp cable to gel electrodes, peel the plastic backing from electrodes and place the IN+, IN-, REF cables according to your specific biopotential recording.

Note

While placing the gel electrodes on the skin, make sure to place the non-sticky tab of the electrode in the direction opposite to your hair growth. This allows you to remove the electrodes easily without pulling off much body hair.

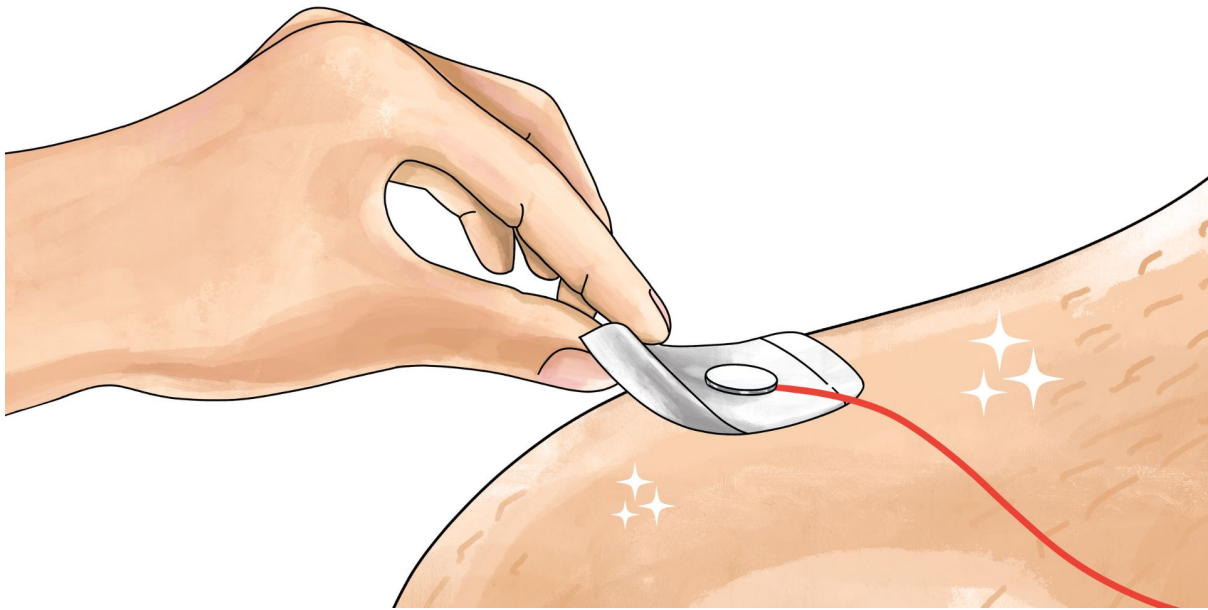

Fig. 7: Placing gel electrodes on skin surface

Using BioAmp bands

Connect the BioAmp cable to your BioAmp band. Now apply a small amount of electrode gel or Ten20 conductive paste on the dry electrodes between the skin and metallic part of BioAmp cable. This improves the signal conductivity, enhancing overall signal quality.

Note

The above graphics demonstrates the use of electrode gel/Ten20 paste with Muscle BioAmp Band. Similarly you can use Brain BioAmp Band and Heart BioAmp Band. Refer to *Using BioAmp Bands* guide to assemble and use all the BioAmp Bands correctly.

Now you are all set! Make all the connections correctly and start recording your biopotential signals.

Warning

NuPrep gel, Ten20 paste and the alcohol swabs shouldn't be used if you have a history of skin allergies to lotions and cosmetics.

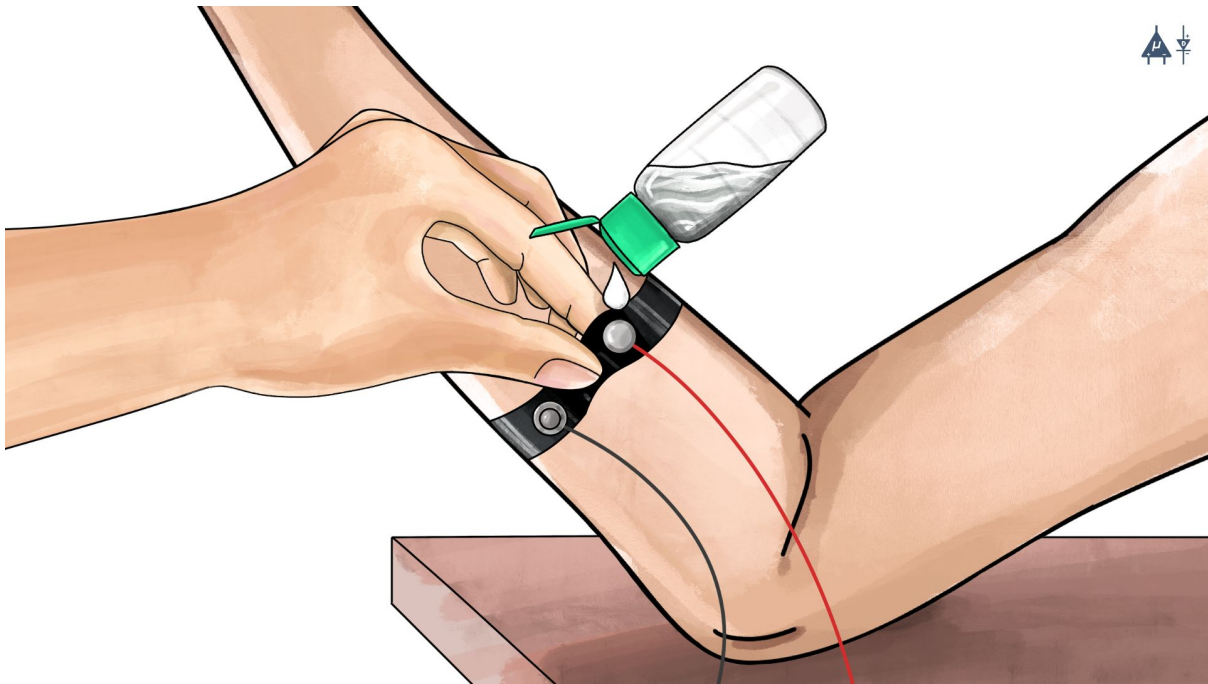

Fig. 8: Method 1: Using Electrode gel

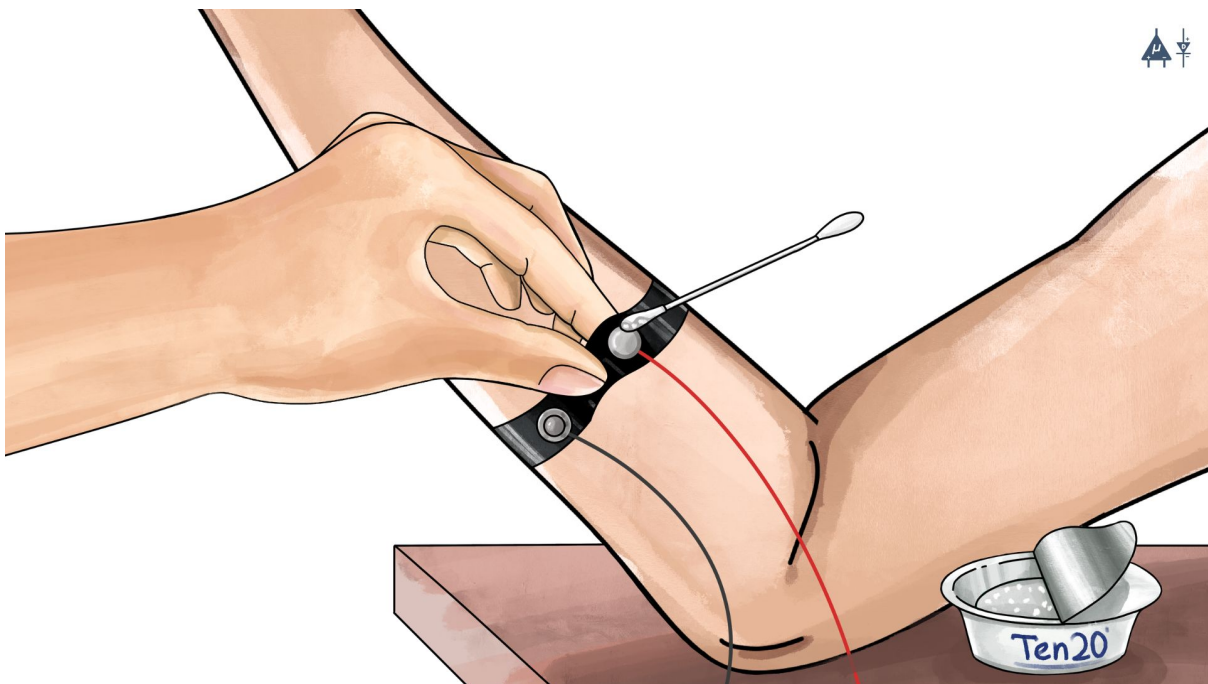

Fig. 9: Method 2: Using Ten20 paste

USING BIOAMP BANDS

3.1 Overview

BioAmp Bands are dry electrode-based stretchable bands that allows you to record biopotential signals from your body be it from brain (EEG), muscles (EMG) or heart (ECG). These bands can only be used with our BioAmp Hardware by making the connections using BioAmp Cable.

3.2 Why use BioAmp Bands?

Usually, people use gel electrodes to record biopotential signals from the skin surface. But, it has its own disadvantages. So we came up with these BioAmp Bands using which users can enjoy a more comfortable, cost-effective, and hassle-free experience while recording biopotential signals.

- **Comfort:** BioAmp Bands are generally more comfortable to wear than gel electrodes, especially for long-term recordings. They conform to the body's shape and avoid the sticky, sometimes irritating sensation of gel electrodes.
- **Reusability:** Unlike gel electrodes, which are often single-use and need to be replaced frequently, BioAmp Bands can be reused multiple times. This makes them more cost-effective and environmentally friendly.
- **Ease of Use:** These bands are easy to wear and adjust, reducing the hassle of setup and ensuring consistent placement.
- **Hygiene:** They can be easily cleaned and sanitized between uses, reducing the risk of skin irritation and infections. Gel electrodes, on the other hand, can leave residue on the skin surface.
- **Performance:** The bands can provide stable and reliable signal recordings depending on your environment conditions. For hot/humid conditions, the bands usually perform better while recording the signals. But if the weather is cold causing dry skin, then it is recommended to prepare the skin properly and apply electrode gel between the metallic part of cable and skin surface. If you feel that the skin impedance is increasing, then reapply electrode gel frequently. The other option is to use gel electrodes after preparing the skin properly.

3.3 Types of BioAmp Bands

There are 3 types of BioAmp Bands and all these bands offer targeted and efficient solutions for recording biopotential signals from the muscles, heart, and brain, making them versatile tools for a wide range of HCI/BCI applications.

3.3.1 1. Muscle BioAmp Band

Muscle BioAmp Band (EMG Band) is a stretchable band that can be connected to any of our Muscle BioAmp Hardware or any EXG sensor using a BioAmp Cable. It allows you to record your muscle signals hassle-free.



Length	13 inches
Stretchability	2X (Upto 26 inches)
Usability	Reusable as it comes with washable fabric
Interface	Snap electrodes
Compatible Hardware	Muscle BioAmp Hardware or any EXG sensor
BioPotentials	EMG
No. of channels	1
Wearable	Yes

3.3.2 2. Heart BioAmp Band

Heart BioAmp Band (ECG Band) is a stretchable band that can be connected to any of our Heart BioAmp Hardware or any EXG sensor using BioAmp Cable. It allows you to record your ECG signals hassle-free.



Length	37 inches
Stretchability	2X (Upto 74 inches)
Usability	Reusable as it comes with washable fabric
Interface	Snap electrodes
Compatible Hardware	Heart BioAmp Hardware or any EXG sensor
BioPotentials	ECG
No. of channels	1
Wearable	Yes

3.3.3 3. Brain BioAmp Band

Brain BioAmp Band (EEG Band) is a stretchable band that can be connected to any of our Brain BioAmp Hardware or any EXG sensor using BioAmp Cable to record signals from the brain hassle-free.

Length	15.5 inches
Stretchability	2X (Upto 31 inches)
Usability	Reusable as it comes with washable fabric
Interface	Snap electrodes
Compatible Hardware	Brain BioAmp Hardware or any EXG sensor
BioPotentials	EEG
No. of channels	2 or 6
Wearable	Yes

You can get either a 2-channel or a 6-channel Brain BioAmp Band according to your project or research requirements:

2-Channel Brain BioAmp Band

It can be used to record EEG signals up to 2 channels either from the visual cortex (back of your head) or the prefrontal cortex part of brain.



6-Channel Brain BioAmp Band

It can be used to record EEG signals up to 2 channels either from the visual cortex (back of your head) or the prefrontal cortex part of brain.



3.4 Using Muscle BioAmp Band

3.4.1 Assembly

1. Take your Muscle BioAmp Band, hold the side of the band that has buckle on it and align the top part of the buckle with the flat surface of the snap.



1. Take the other end of the band and insert it in the buckle.
3. Your band is now ready to use. You can also adjust the size of the band according to your targeted muscle.

Take other end of the band and
insert it in the buckle



Insert this end of the band into the buckle
as shown and pull it to finish the assembly





3.4.2 Skin Preparation

Apply Nuprep Skin Preparation Gel on the skin surface where dry electrodes would be placed to remove dead skin cells and clean the skin from dirt. After rubbing the skin surface thoroughly, clean it with an alcohol wipe or a wet wipe.

For more information, please check out detailed step by step *Skin Preparation Guide*.

3.4.3 Measure EMG

1. Flip the band and snap the dry electrodes of the BioAmp Cable on it as shown below.

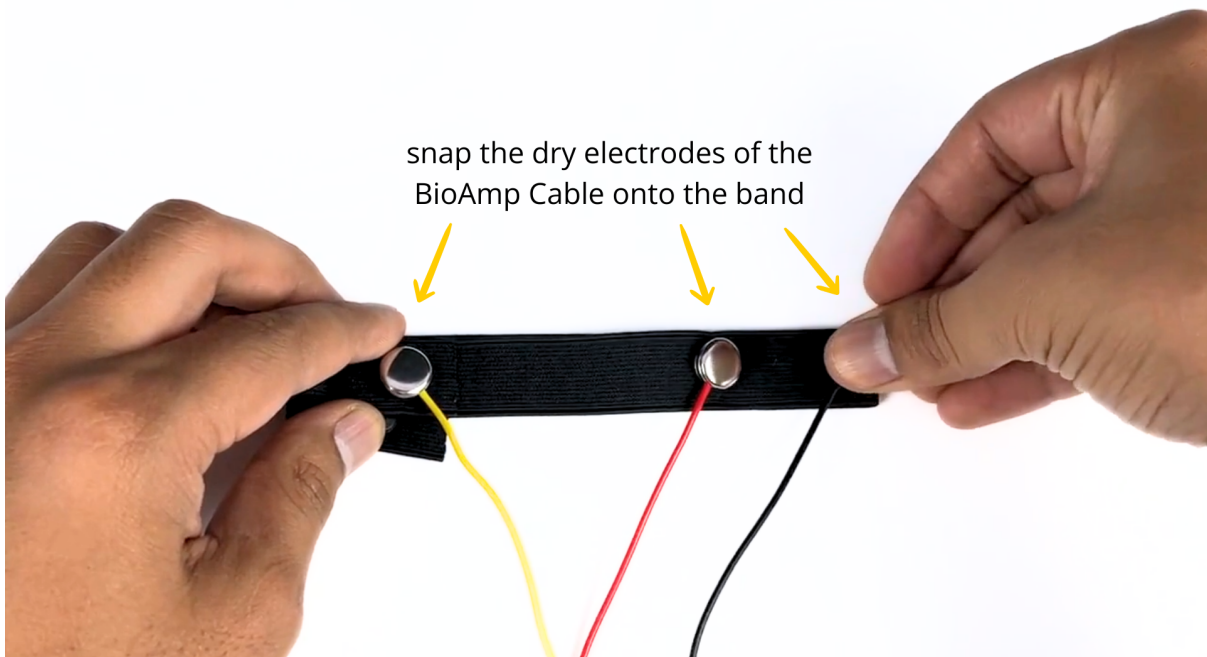

1. Flip the band again and wear it on your arm in such a way that IN+ and IN- are placed on the arm near the ulnar nerve and REF (reference) on the farther side of the band.

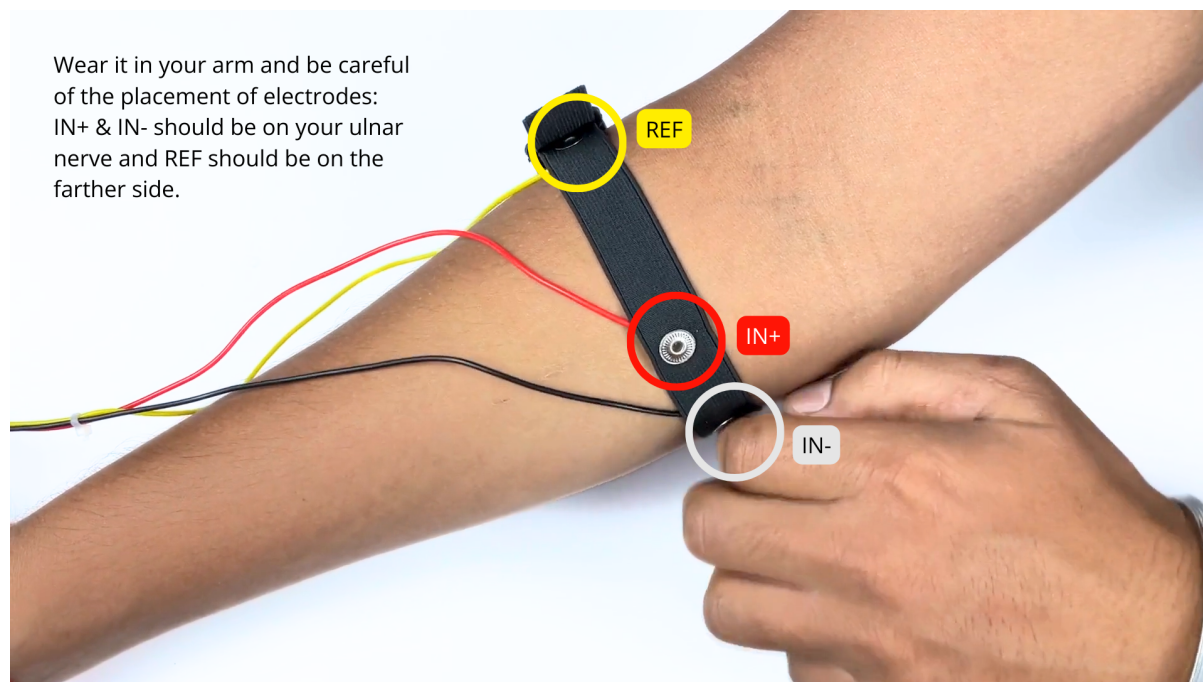

Note

Make sure the dry electrodes (shiny parts of the BioAmp Cable) are in direct contact with the skin.

3. Now put a small amount of electrode gel or Ten20 paste between the skin and dry electrodes to get the best signal acquisition.

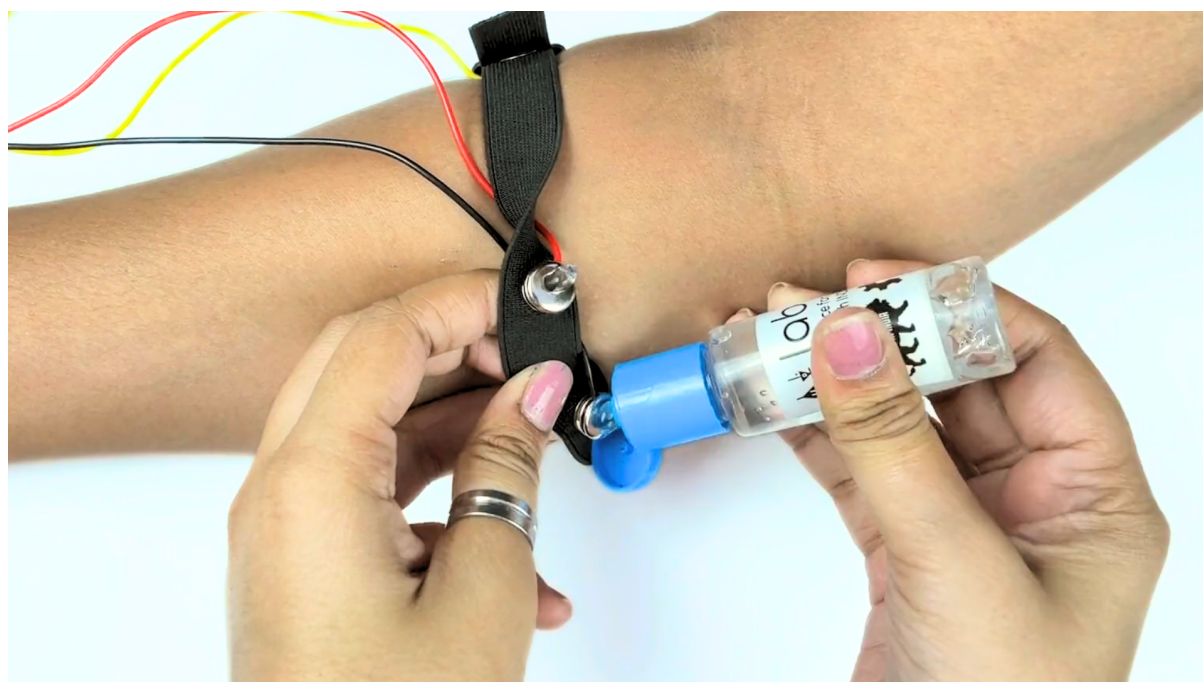

Note

- After using the band, don't leave the gel residue on the dry electrodes longer than an hour as it may corrode them over a period of time.
- Wash the band with liquid soap and rinse it properly after every use. Use it again only when it is completely dry.

3.5 Using Heart BioAmp Band

3.5.1 Skin Preparation

Apply Nuprep Skin Preparation Gel on your chest where dry electrodes would be placed to remove dead skin cells and clean the skin from dirt. After rubbing the skin surface thoroughly, clean it with an alcohol wipe or a wet wipe.

For more information, please check out detailed step by step *Skin Preparation Guide*.

3.5.2 Assembly

1. Take your Heart BioAmp Band and wrap the band around your chest in such a way that the pointy part of the snap touches your chest and the flat part is on the outer side.

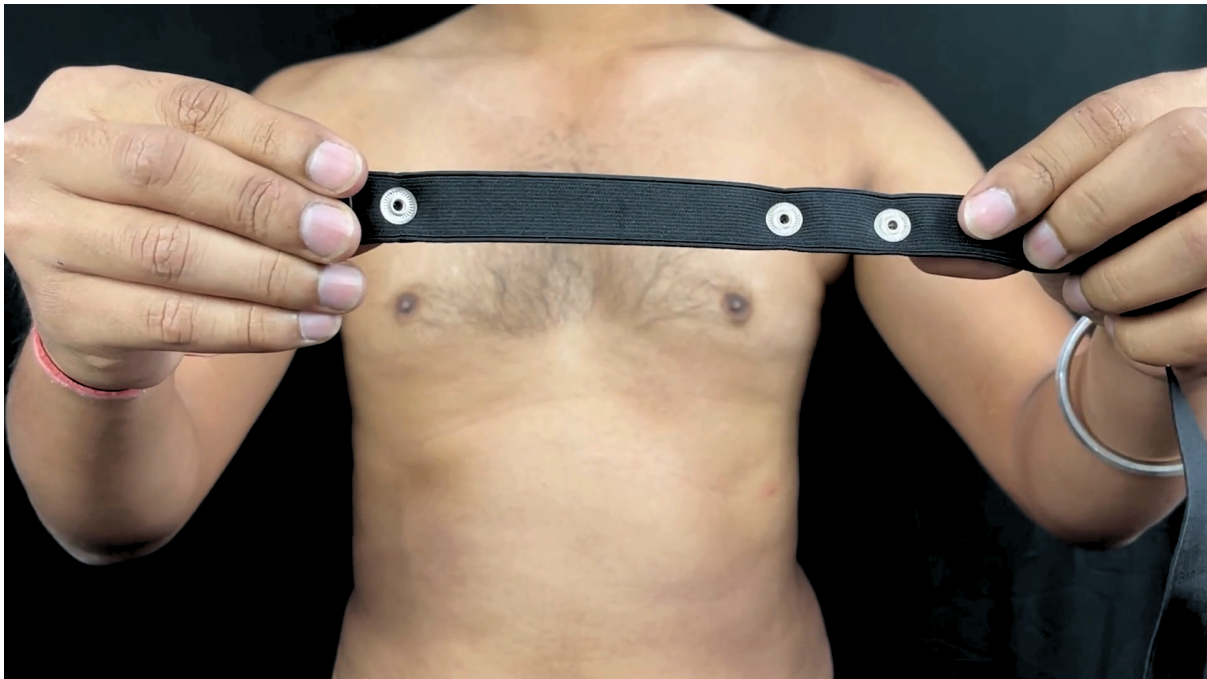

2. Now insert the loose end of the band into the buckle and tighten it by pulling the strap.
3. Your band is now ready to use. You can also adjust the size of the band according to your chest size.



3.5.3 Measure ECG

1. Snap the IN- cable on the left most side of the band, IN+ cable in the middle, and REF cable on the right side as shown below.

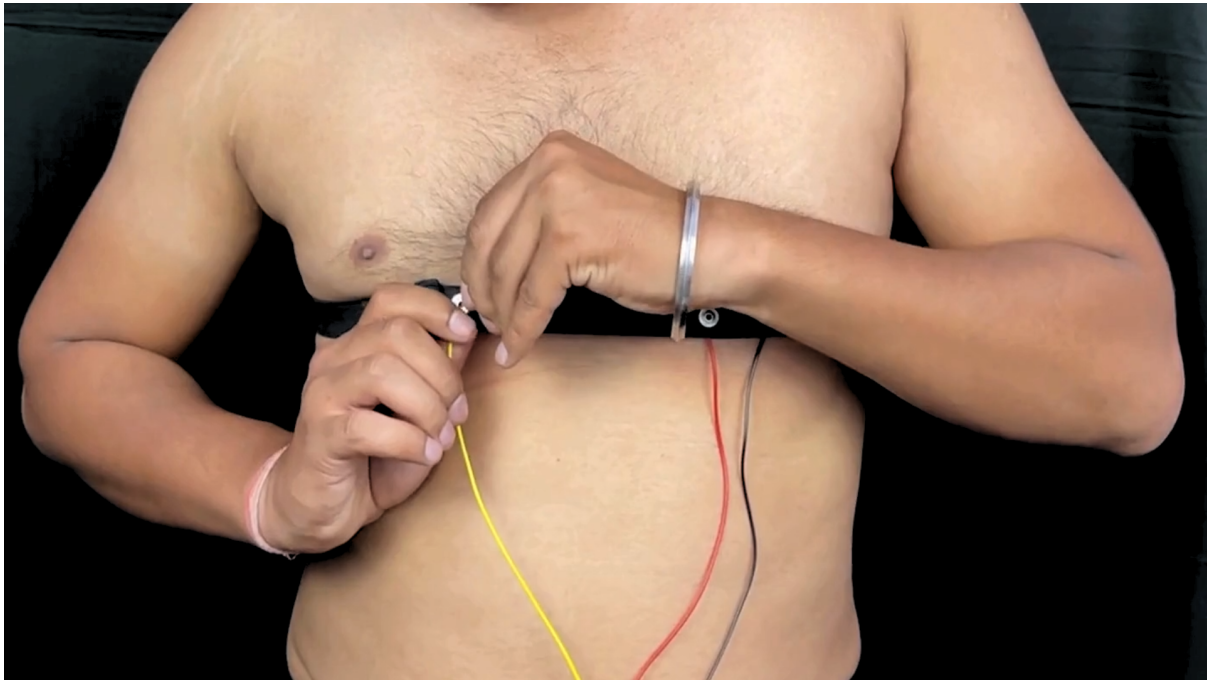

Note

Make sure the dry electrodes (shiny parts of the BioAmp Cable) are in direct contact with the skin.

2. Now put a small amount of electrode gel or Ten20 paste between the skin and dry electrodes to get the best signal acquisition.



Note

- After using the band, don't leave the gel residue on the dry electrodes longer than an hour as it may corrode them over a period of time.
- Wash the band with liquid soap and rinse it properly after every use. Use it again only when it is completely dry.

3.6 Using Brain BioAmp Band

3.6.1 Assembly

You get the band in two parts - the longer part consists of buckles at both ends and the shorter one has loose ends on both sides.

1. Hold one end of the longer band and align the top part of the buckle with the flat surface of the snap.
2. Now take the shorter band and insert it into the buckle of longer band.
3. Repeat step 1 and 2 for the other buckle on the longer band.
4. Your band is now ready to use. You can also adjust the size of the band according to your head size.

3.6.2 Skin Preparation

Apply Nuprep Skin Preparation Gel on your targeted area (visual cortex or prefrontal cortex) where dry electrodes would be placed to remove dead skin cells and clean the skin from dirt. After rubbing the skin surface thoroughly, clean it with an alcohol wipe or a wet wipe.

For more information, please check out detailed step by step *Skin Preparation Guide*.

3.6.3 Measure 1-channel EEG

1. Flip the band, take your BioAmp Cable, and snap the REF cable on a gel electrode. Now snap the IN- and IN+ cable on:
 - Fp1 and Fp2 positions for recording EEG from prefrontal cortex
 - O1 and O2 positions for recording EEG from visual cortex

Note

The electrode positions mentioned above are according to [International 10-20 system for recording EEG](#).

2. Flip the band again and wear it in a way so that the dry electrodes (shiny parts of the cable) are in contact with:
 - skin surface on the forehead (if recording from prefrontal cortex)
 - scalp surface on the back side of your head (if recording from visual cortex)
3. Peel of the plastic backing of the gel electrode and place it on the bony part behind your earlobe.

Note

While placing the gel electrodes on the skin, make sure to place the non-sticky tab of the electrode in the direction opposite to your hair growth. This allows you to remove the electrodes easily without pulling off much body hair.

4. Now put a small amount of electrode gel or Ten20 paste between the skin/scalp and dry electrodes to get the best signal acquisition.